

**Disassembly, Assembly Instructions - 2.8 hp Grinder/Sander Series:
Ø 7" & 9", Right Angle**

Models: Use for all models.

Important: Disconnect from the air supply.

Notice: Use these instructions along with the specific tool manual for each model. To avoid damage, use the proper repair tools designed for motor disassembly and assembly.

- Remove any flanges, abrasive, back-up disc or guard.

Motor Disassembly: (Tutorial shows tool with 54951 Spindle. - Applies to all models.)



1. Fasten housing in vise (bronze or aluminum jaws) with throttle handle pointing up.
 - Use a 4mm hex key to remove **95720** Screws (4). Turn counterclockwise.

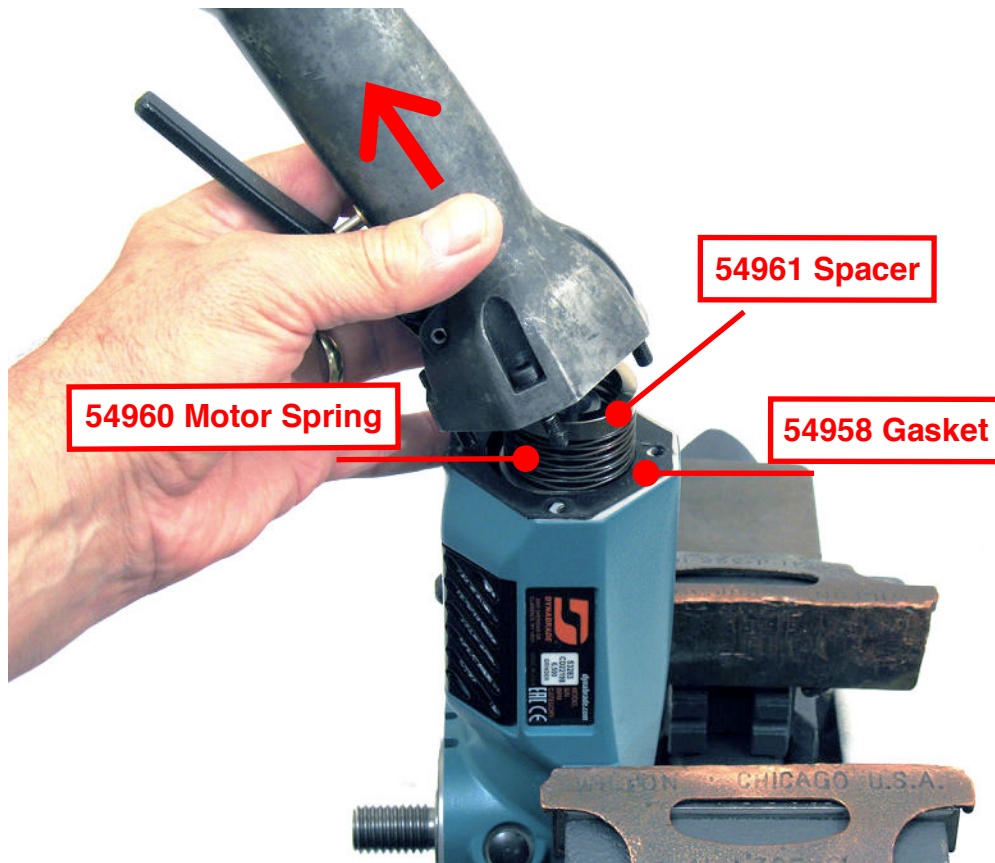

2. Remove throttle handle assembly.

- Remove **54961** Spacer, **54960** Motor Spring, and **54958** Gasket.



3. Remove **54953** Governor Chamber.

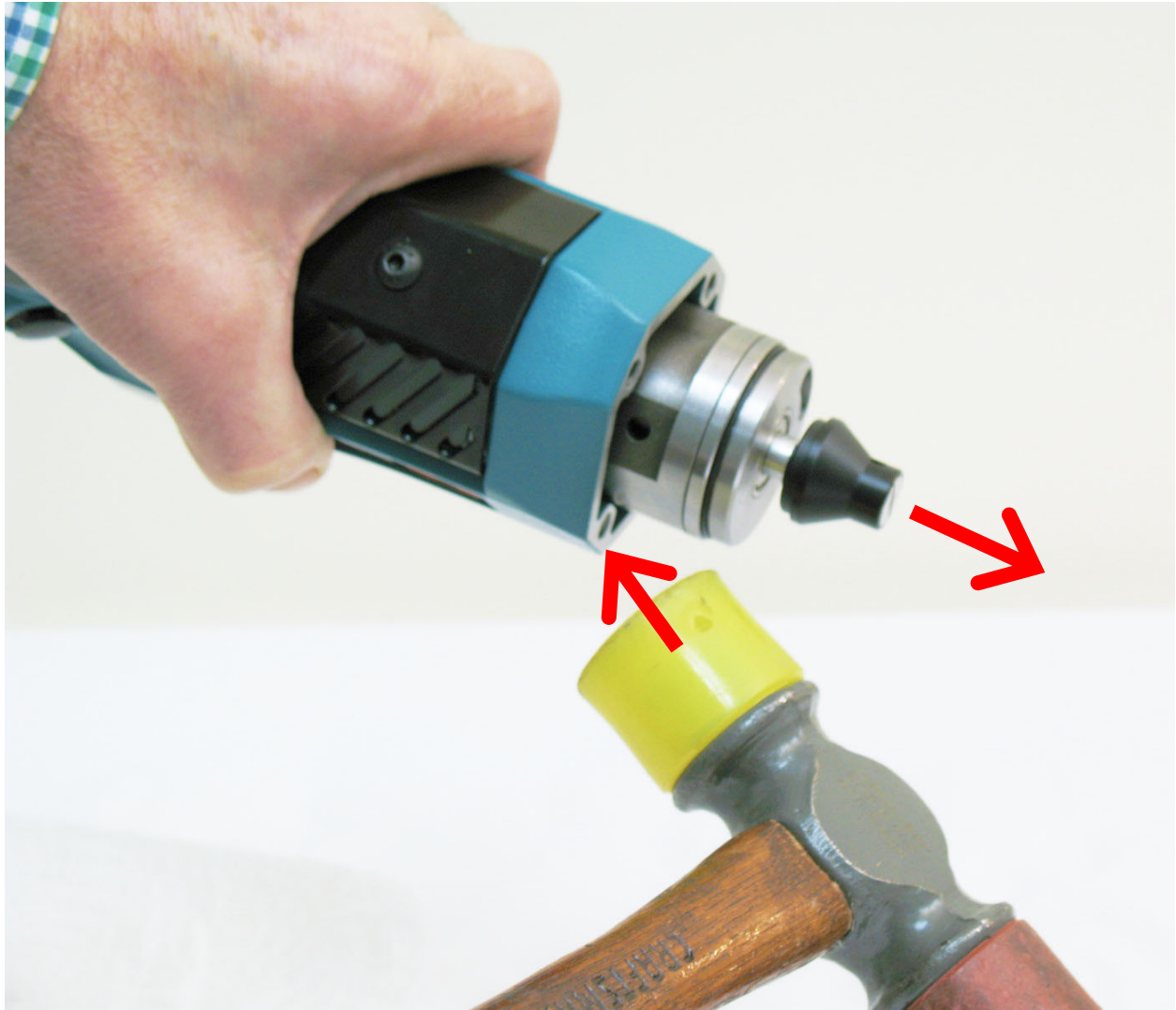

4. Use soft-faced hammer to knock motor assembly loose from housing and remove.



5. Carefully, fasten pinion gear in vise (bronze or aluminum jaws).
 - Use a slot-blade screwdriver to remove governor assembly. Turn clockwise.
Left Hand Thread

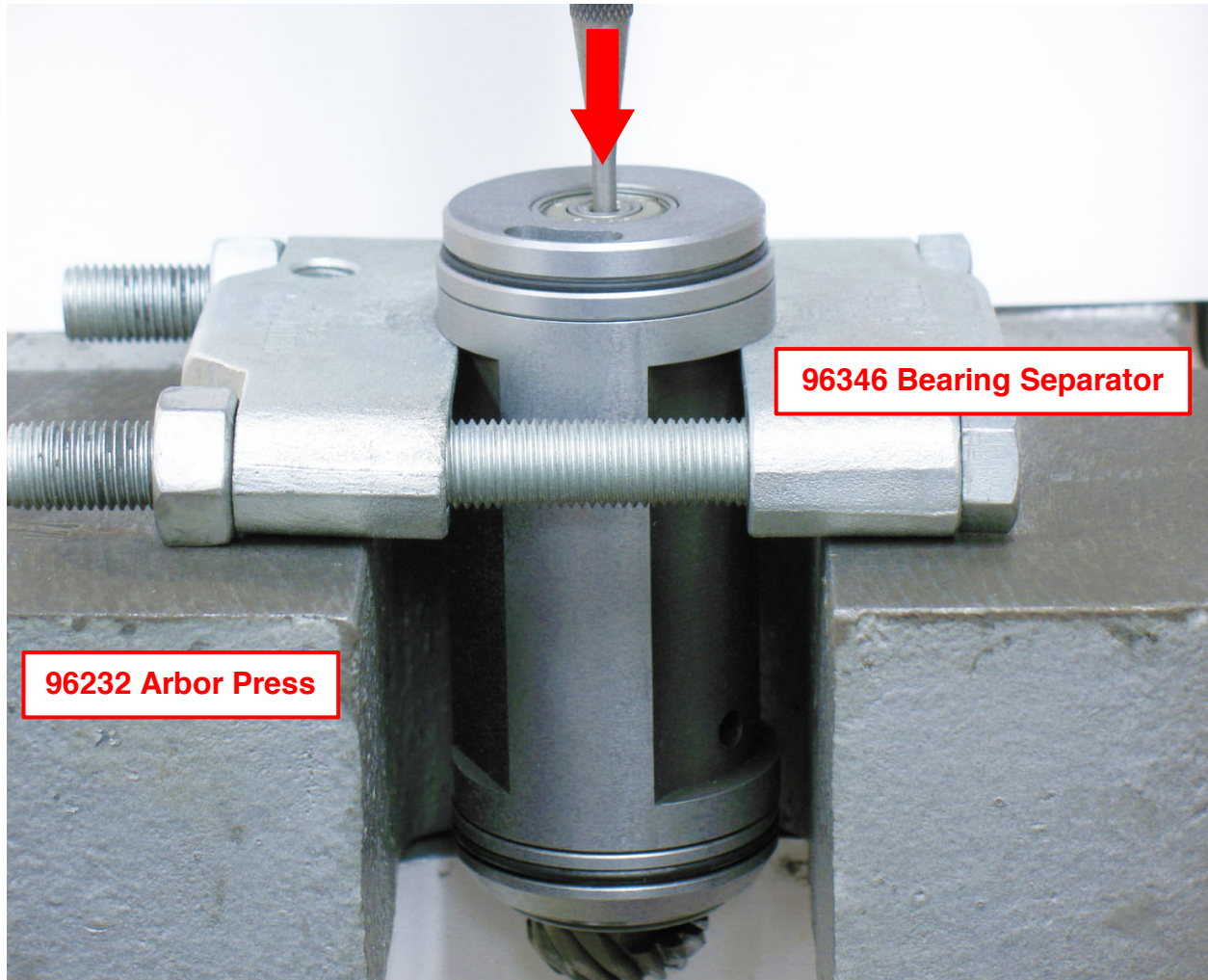

6. Fasten **96346** Bearing Separator (2") around **54905** Cylinder. Place separator and motor in **96232** Arbor Press (#2) with pinion gear pointing down.
 - Use a $\varnothing \frac{1}{8}$ " flat-end drive punch to push rotor out of **54907** Bearing.

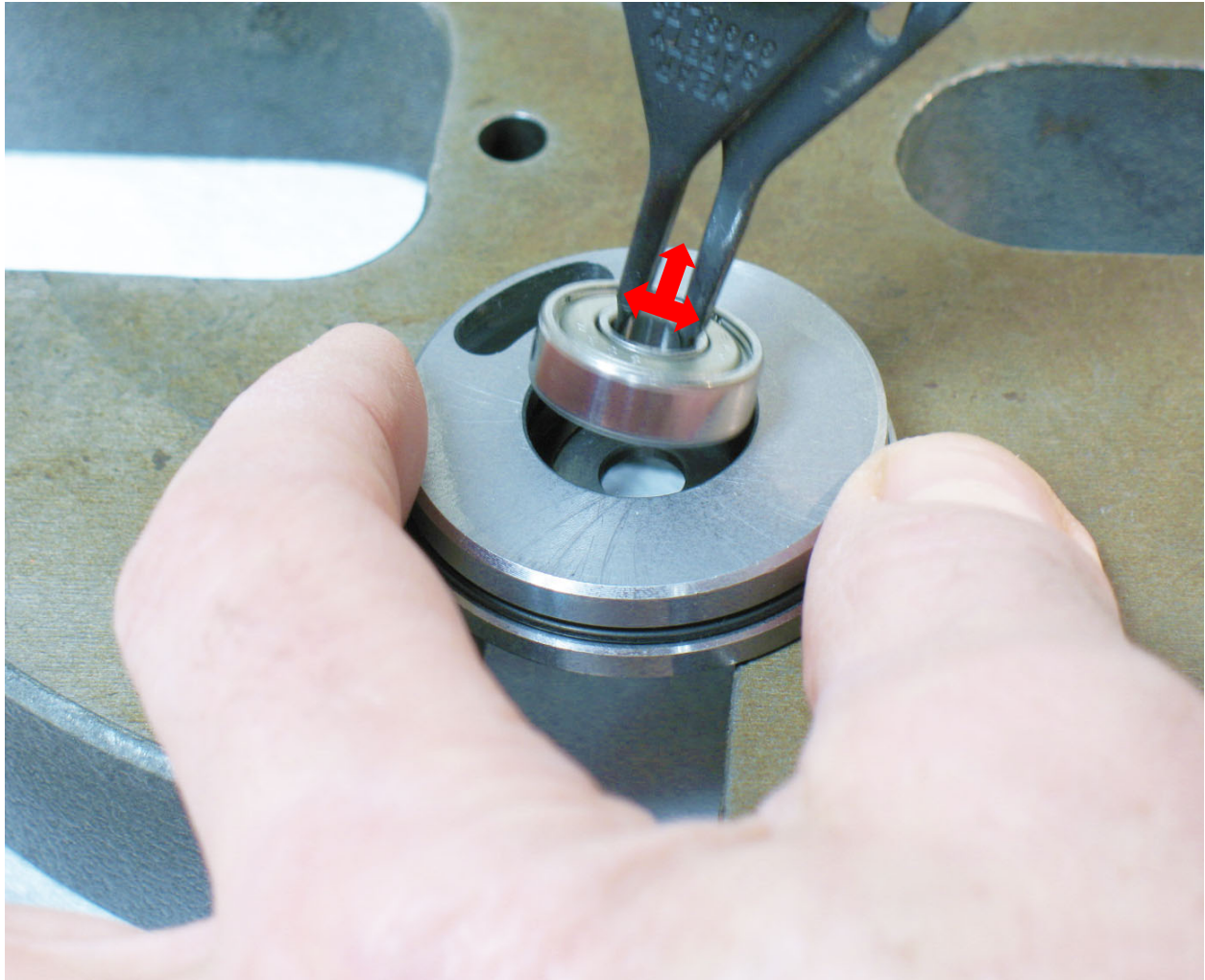

7. Use external ring pliers to remove **54907** Bearing from **54880** Rear End Plate.

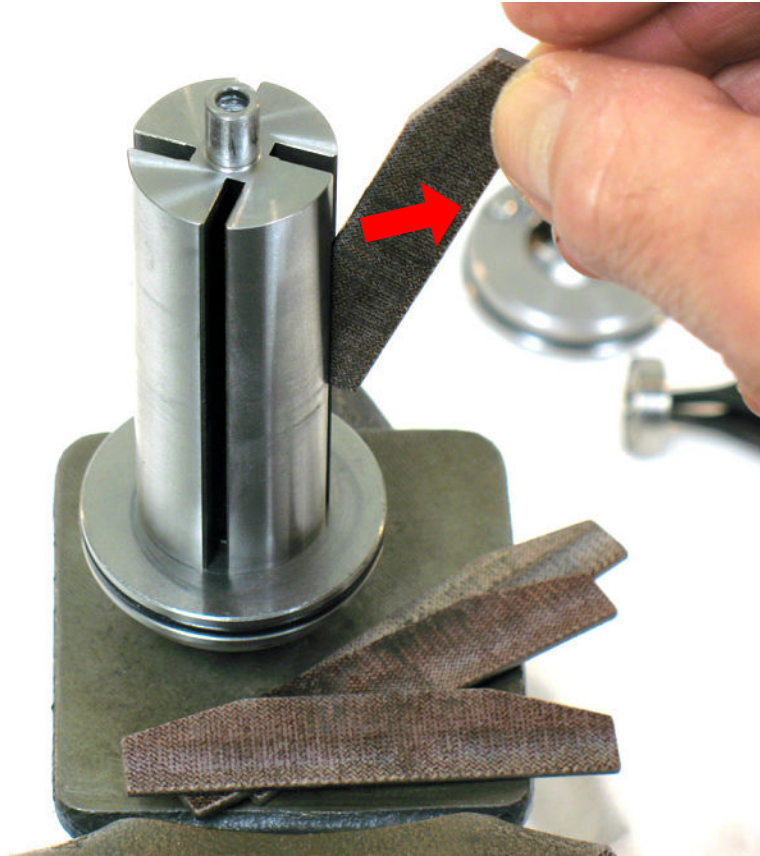

8. Remove **54904** Vanes from **54903** Rotor.

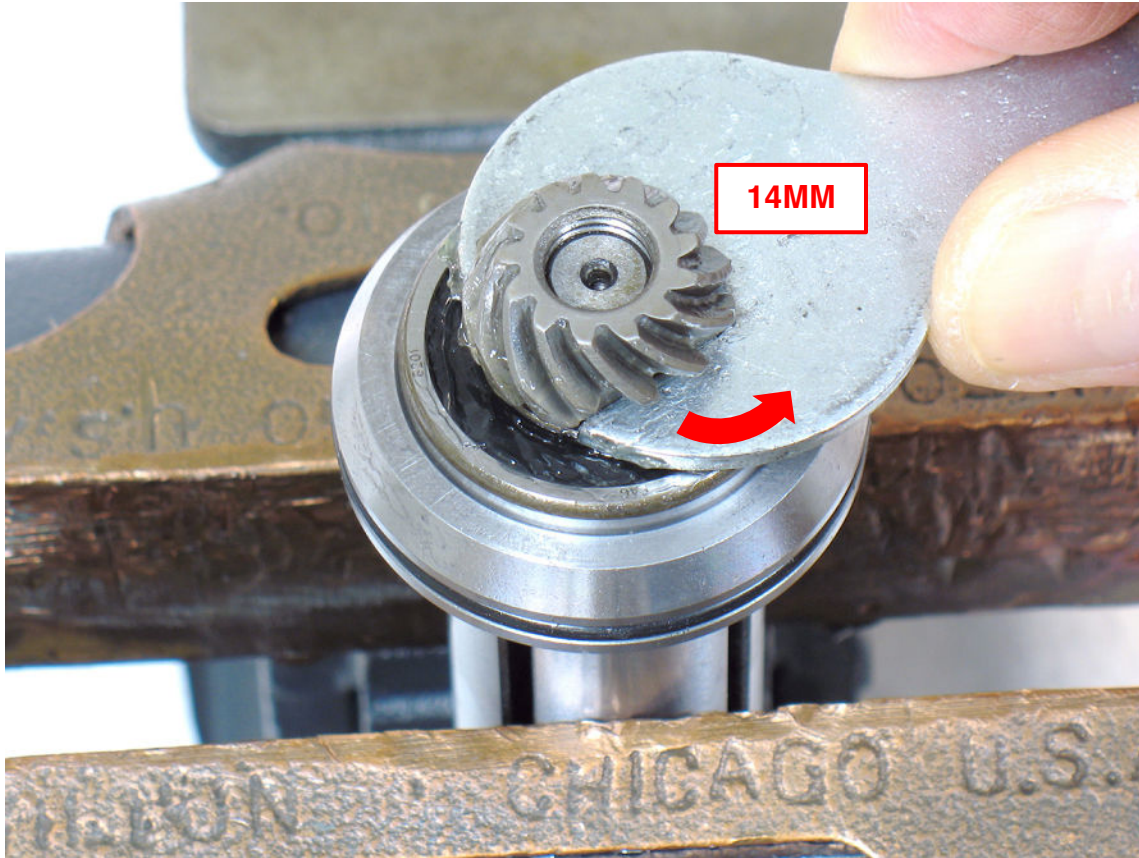

9. Use **95262** Wrench (14mm) to remove pinion gear. Turn counterclockwise.

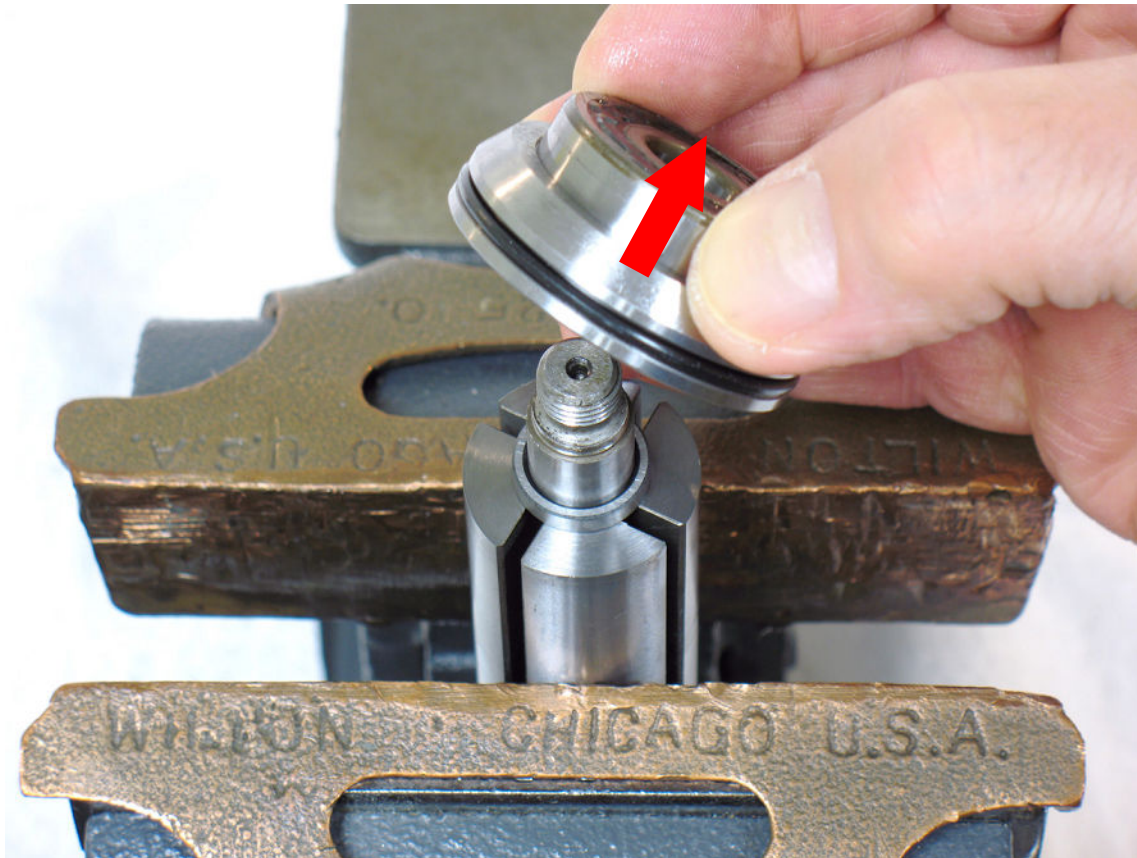

10. Remove; **54900** Bearing, **54901** Front End Plate along with shims and **54902** Spacer.

Motor disassembly completed.

Clean and inspect parts. Replace all parts that are worn or damaged.

Motor Assembly:



1. Fasten **54903** Rotor in vise (bronze or aluminum jaws), with spindle pointing up.
 - Install **54902** Spacer onto rotor.



2. Install **54909** Shim into **54901** Front End Plate.

- Select .003" (~0.08 mm) shim thickness from **94910** Shim Pack and install into front end plate.
- Install **01787** O- Ring into outside diameter groove of plate.
- Install **54900** Bearing all the way into plate.

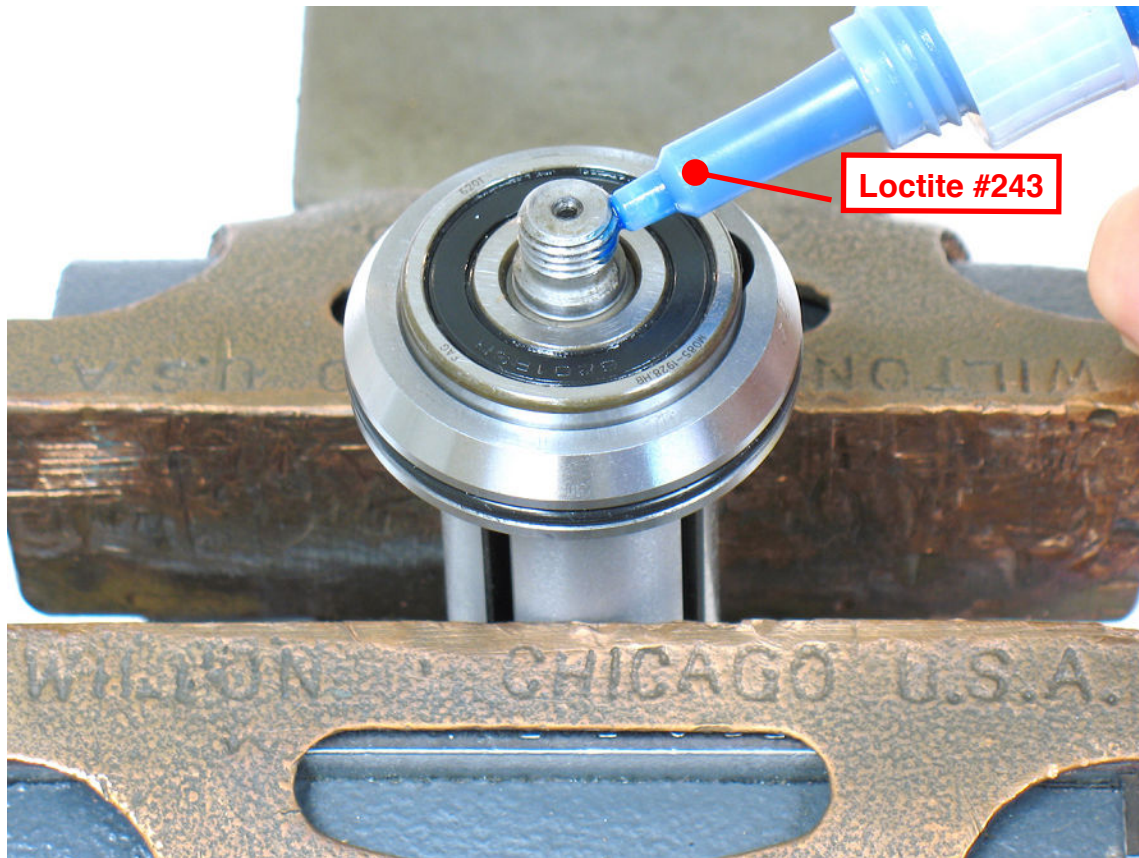

3. Install bearing and plate onto rotor.
 - Apply a small amount of Loctite #243 to spindle threads of rotor.

Torque to: 17 N·m/~150 lbs. in.



4. Use 14mm Wrench (or thin crowfoot) to fasten pinion gear. Turn clockwise.
 - Torque to: 17 N·m/~150 lbs. in.

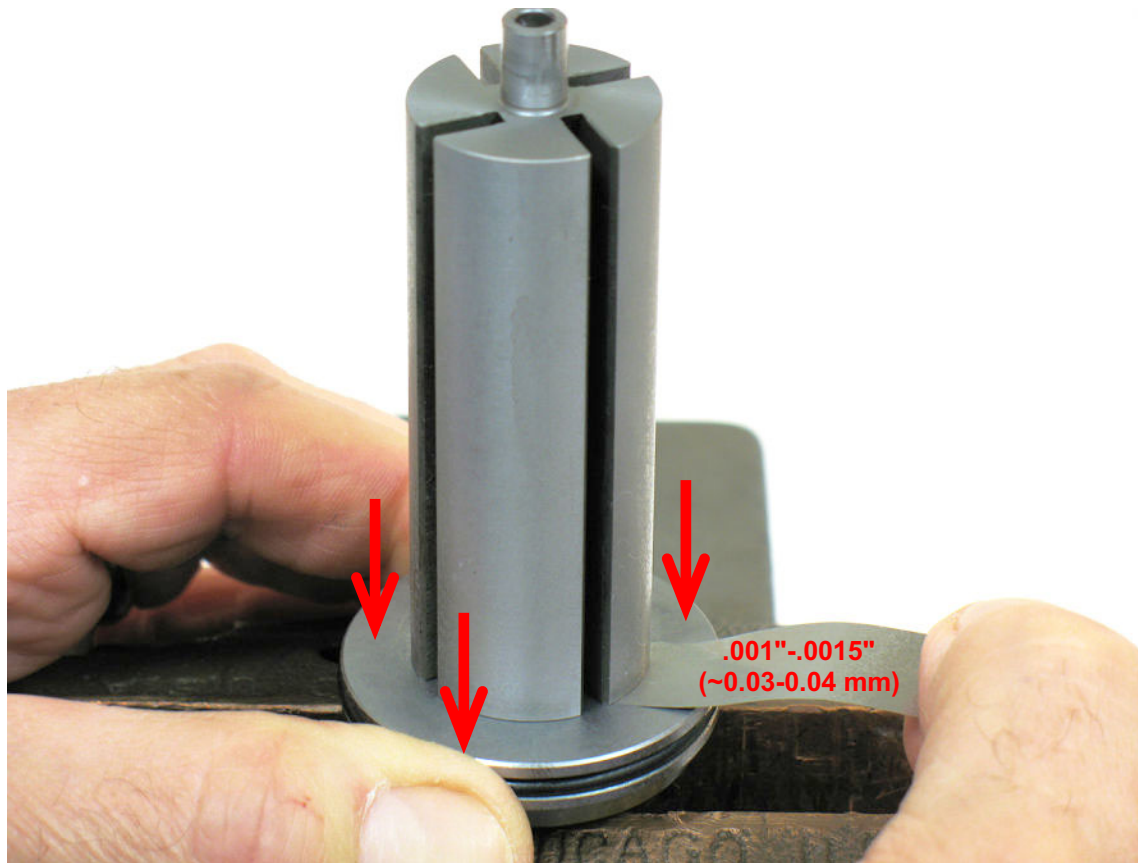

5. Carefully, fasten pinion gear in vise (bronze or aluminum jaws). Push the front-end plate away from the rotor. Check clearance between the rotor and plate.
- Use a .001" (~0.03 mm) thick feeler gauge.
 - **Notice:** The clearance should be .001"-.0015" (~0.03 to ~0.04 mm).
 - If rotor/plate clearance requires further adjustment, repeat steps 2 to 5. Remove or add shims as required.

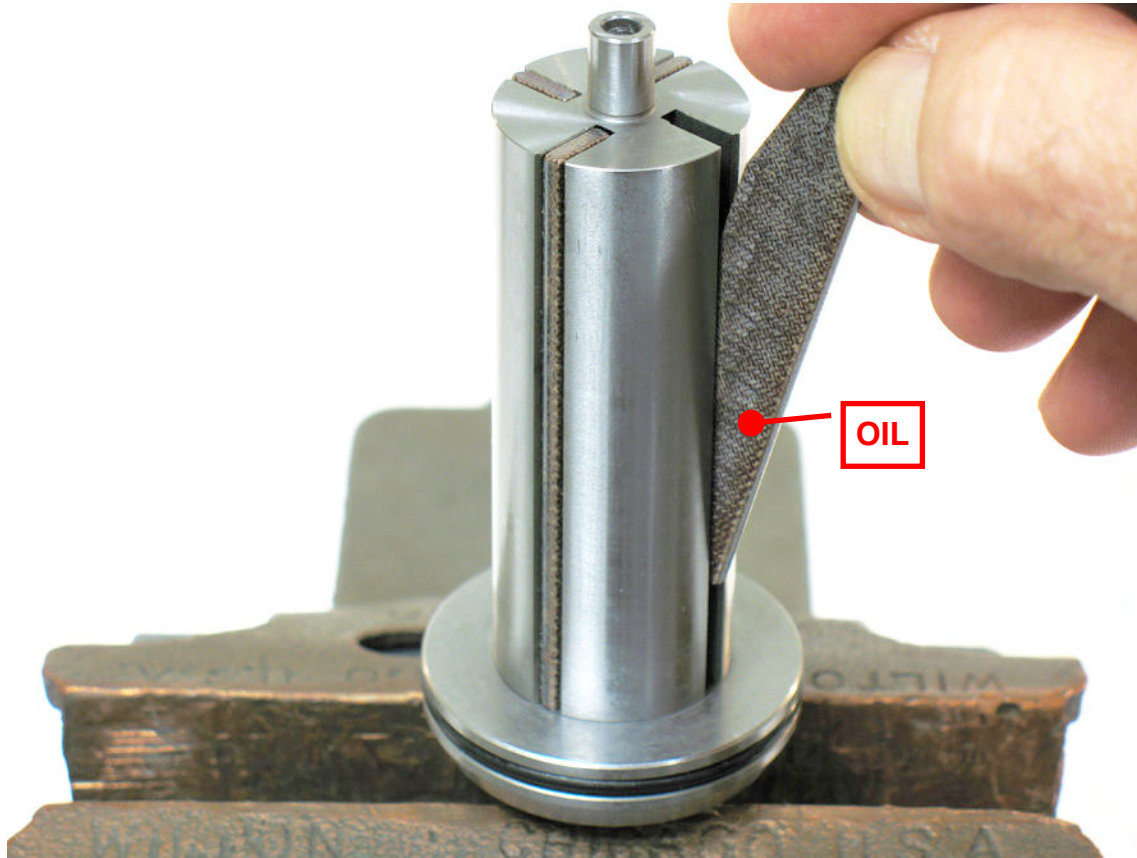

6. Apply **95842** Dynabrade Air Lube 10W/NR or equivalent to **54904** Vanes and install.



7. Install **54905** Cylinder and rear end plate so that air inlet openings line up.

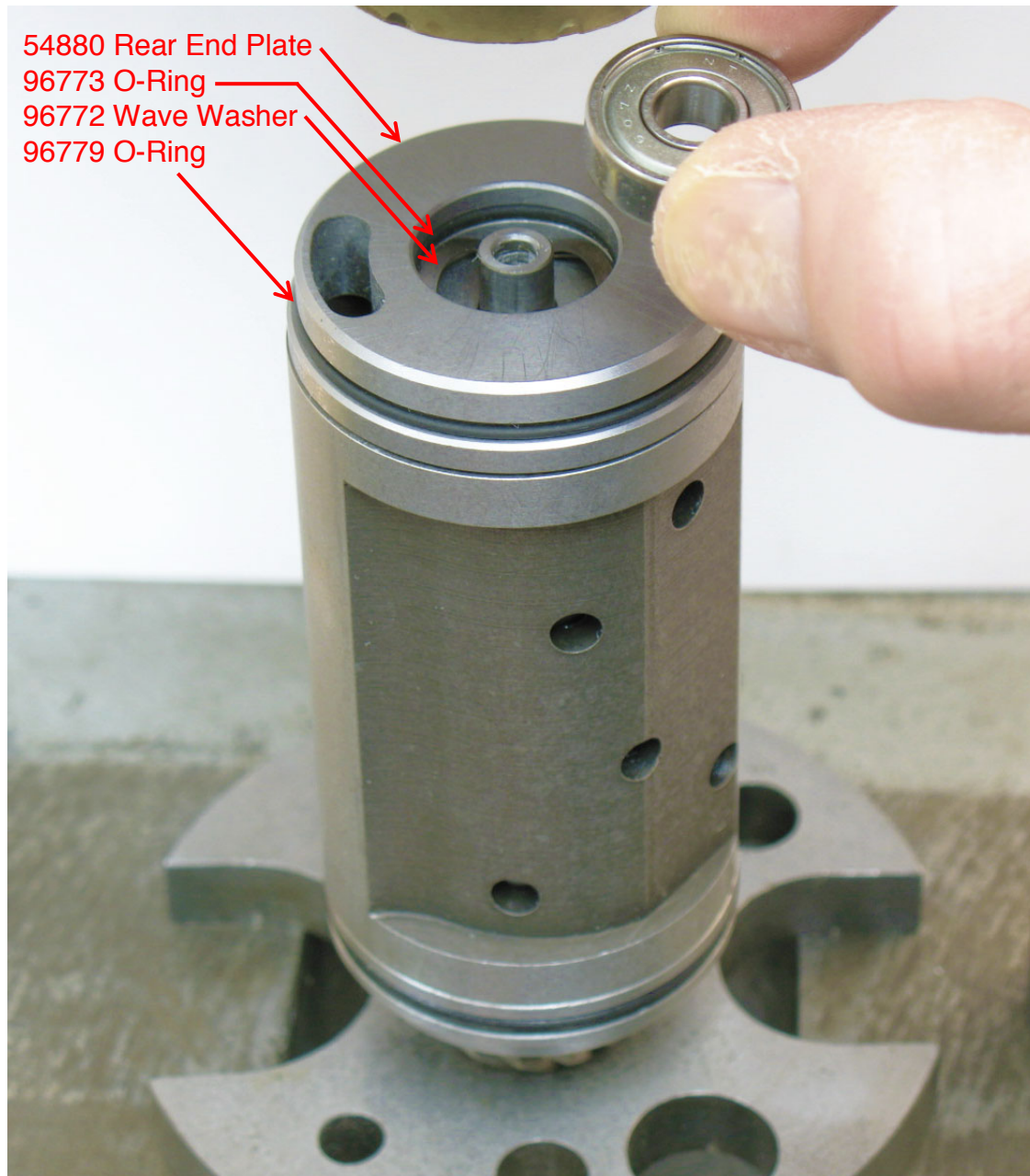

8. Install **54880** Rear End Plate with related components.
- Position **54907** Bearing on assembly.



9. Use the **RAISED INSIDE DIAMETER** of 96419 Bearing Press Tool, and the arbor press to install rear bearing.
- Press bearing flush with top of plate.
This will produce ~12 Lbs. load between both bearing plates and the cylinder.

Left Hand Thread. Turn counterclockwise. Torque to: 1.4 N·m/~12 lbs. in.



10. Carefully, fasten pinion gear in vise (bronze or aluminum jaws).
- Apply a small amount of Loctite #243 to threads of governor.
 - Use a slot-blade torque-driver to install governor assembly.
 - Left Hand Thread. Turn counterclockwise. Torque to: 1.4 N·m/~12 lbs. in.

Motor assembly completed.

Motor Installation:



1. Fasten housing in vise (bronze or aluminum jaws).
 - Carefully slide motor assembly into housing.
 - Install **54953** Governor Chamber with **95526** O-Ring.

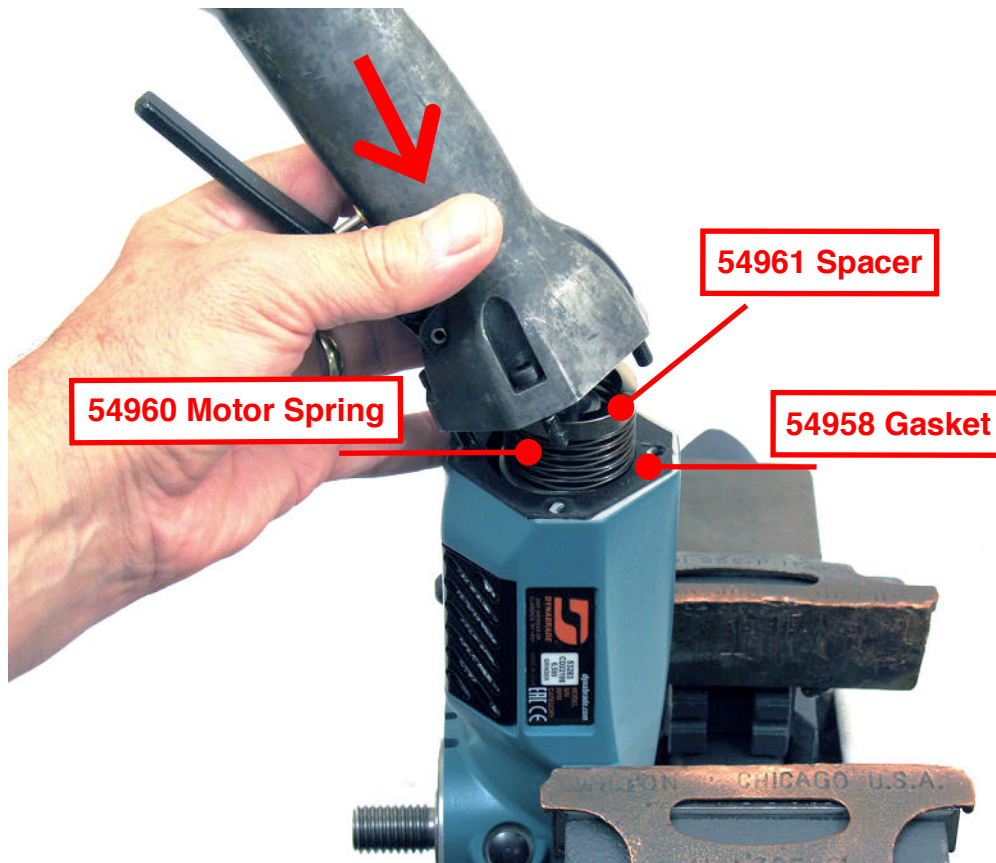

2. Install **54958** Gasket, **54960** Motor Spring, **54961** Spacer.
 - Install throttle handle assembly and **95720** Screws (4).

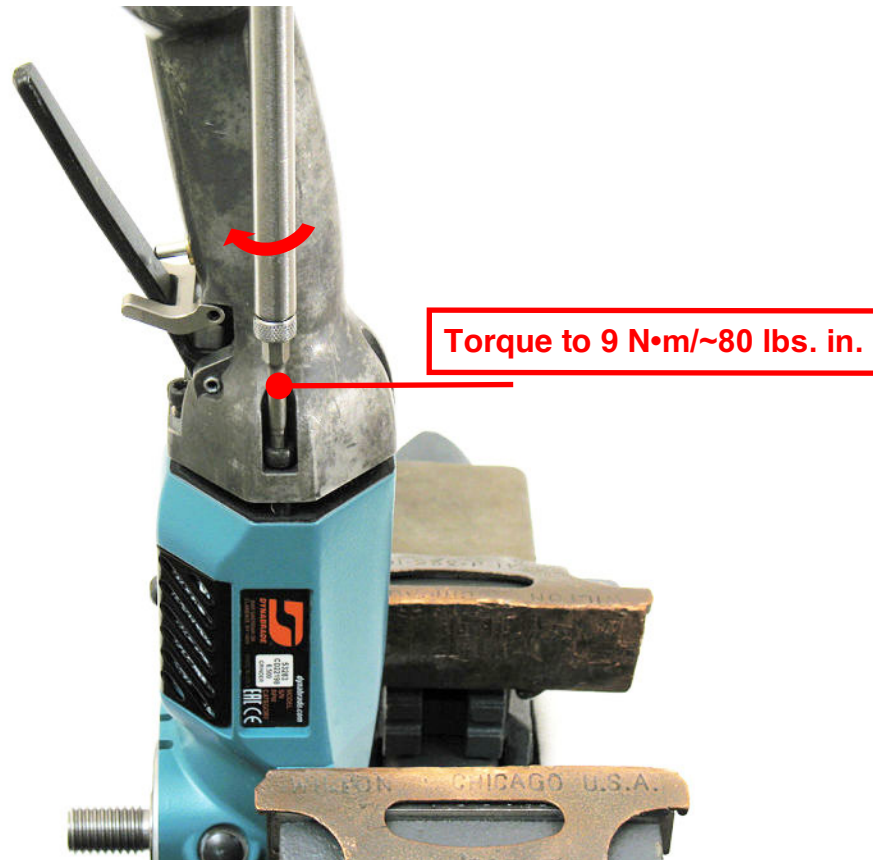

3. Use a 4mm hex key to fasten **95720** Screws (4). Turn clockwise.
 - Torque to 9 N•m/~80 lbs. in.

Motor installation completed.

**Disassembly, Assembly Instructions - 2.8 hp Grinder/Sander Series:
Ø 7" & 9", Right Angle**

Models: Use for all models.

Important: Disconnect from the air supply.

Notice: Use these instructions along with the specific tool manual for each model. To avoid damage, use the proper repair tools designed for motor disassembly and assembly.

- Remove any flanges, abrasive, back-up disc or guard.

Gear Disassembly: (Tutorial shows tool with 54951 Spindle. - Applies to all models.)

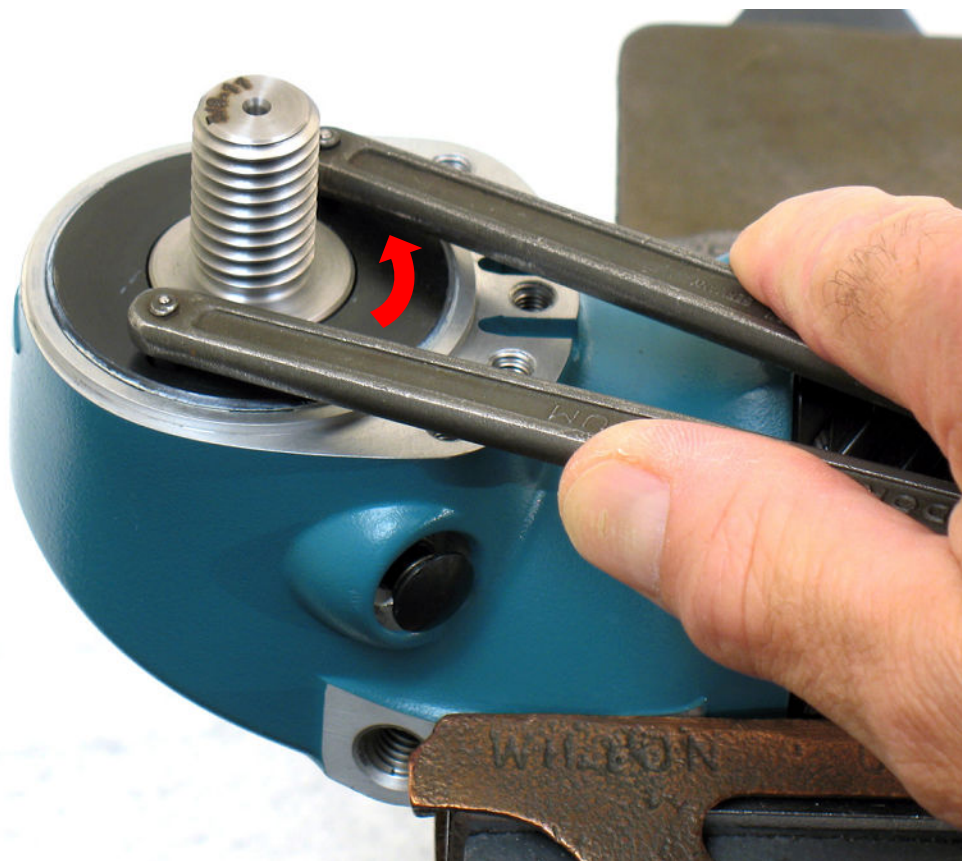

1. Use an adjustable pin spanner (Ø 4mm pins) to remove **54952** Lock Ring.
 - Turn counterclockwise.



2. Remove work spindle assembly from housing.



3. Use tweezers to remove **97995** Wave Disc.

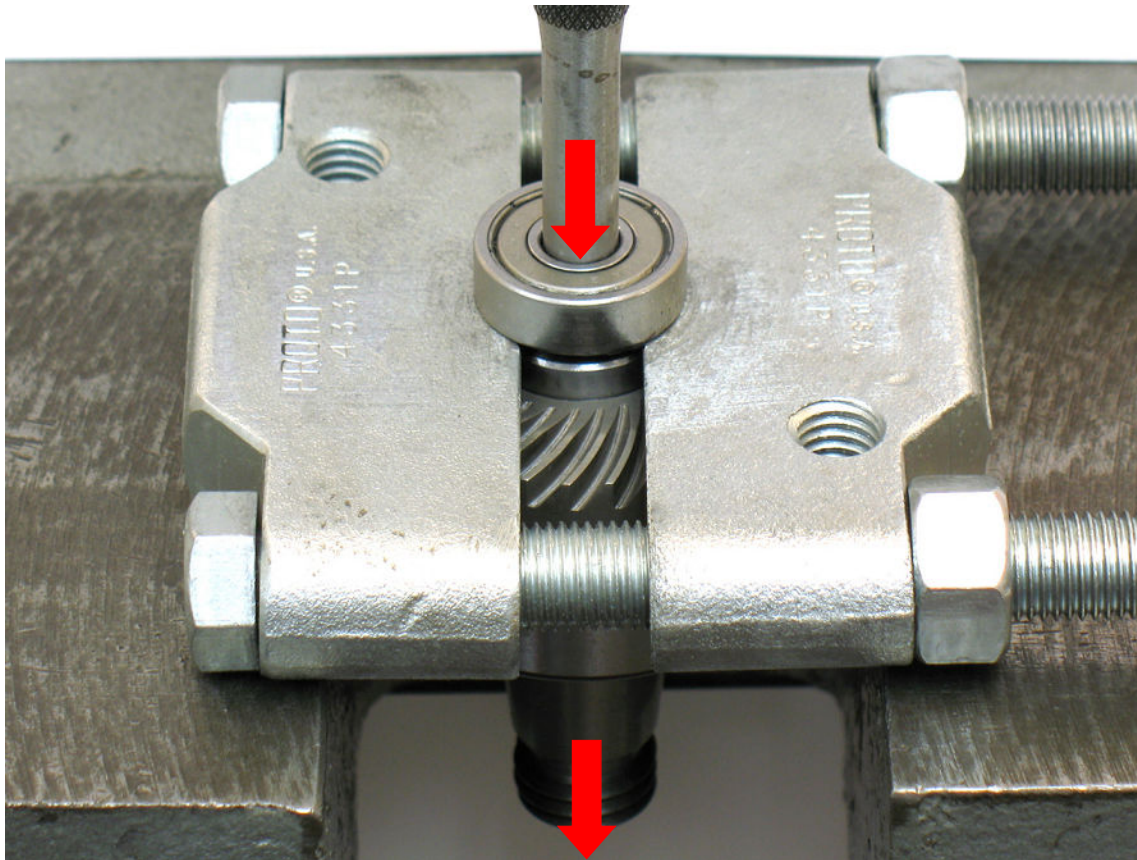

4. Use **96346** Bearing Separator (2") and **96232** Arbor Press (#2) to remove **02649** Bearing.
 - Use $\text{Ø } 5/16$ " flat-end drive punch to push spindle from bearing.

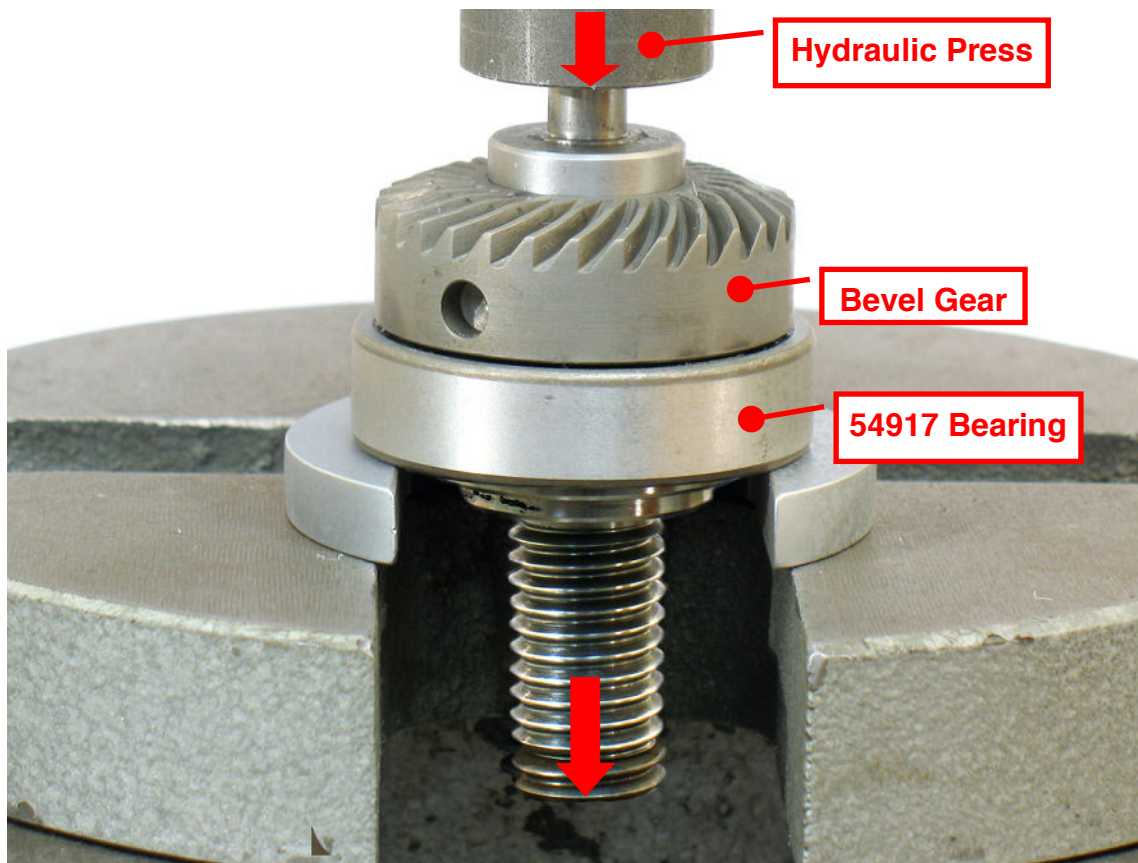

5. Support **54917** Bearing in a hydraulic press with spindle pointing down.
 - Push spindle from **54917** Bearing and bevel gear, removing both at the same time.

Gear disassembly completed.

Clean and inspect parts. Replace all parts that are worn or damaged.

Gear Assembly:

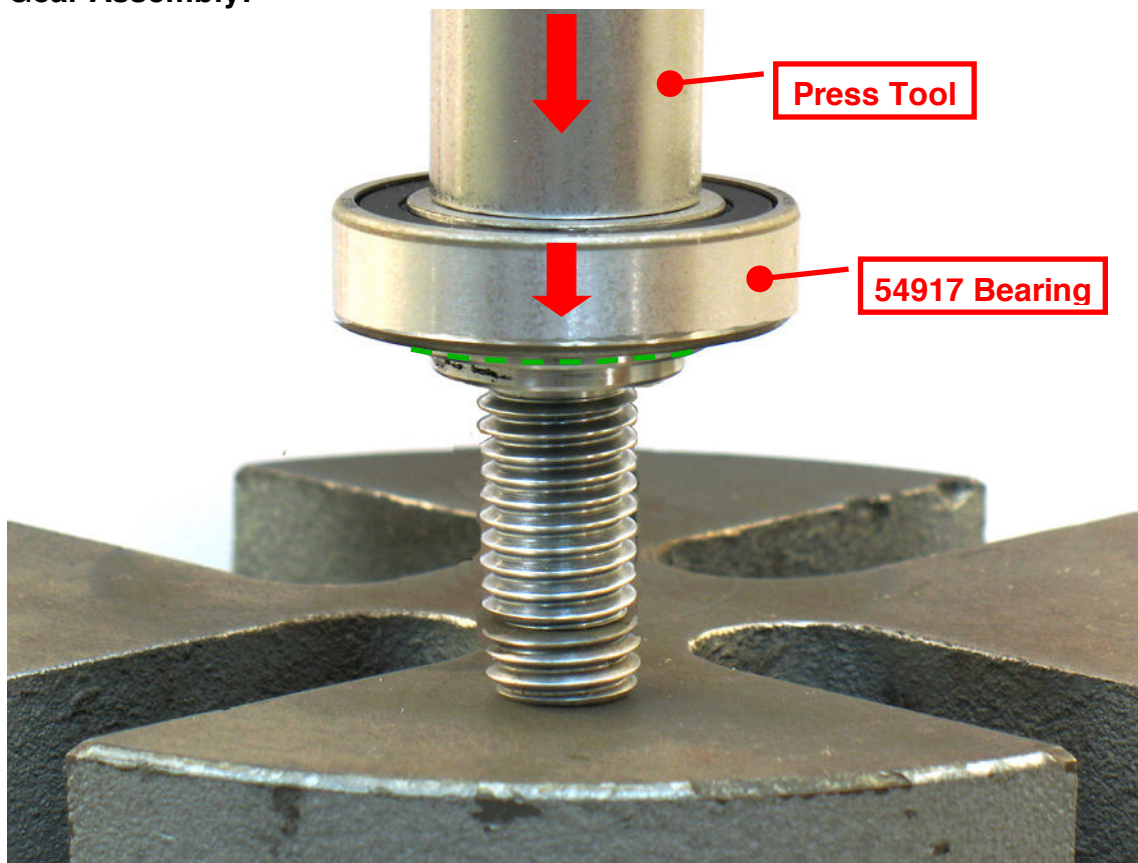

1. Use press to install **54917** Bearing onto spindle.
 - Press until fully seated on spindle.

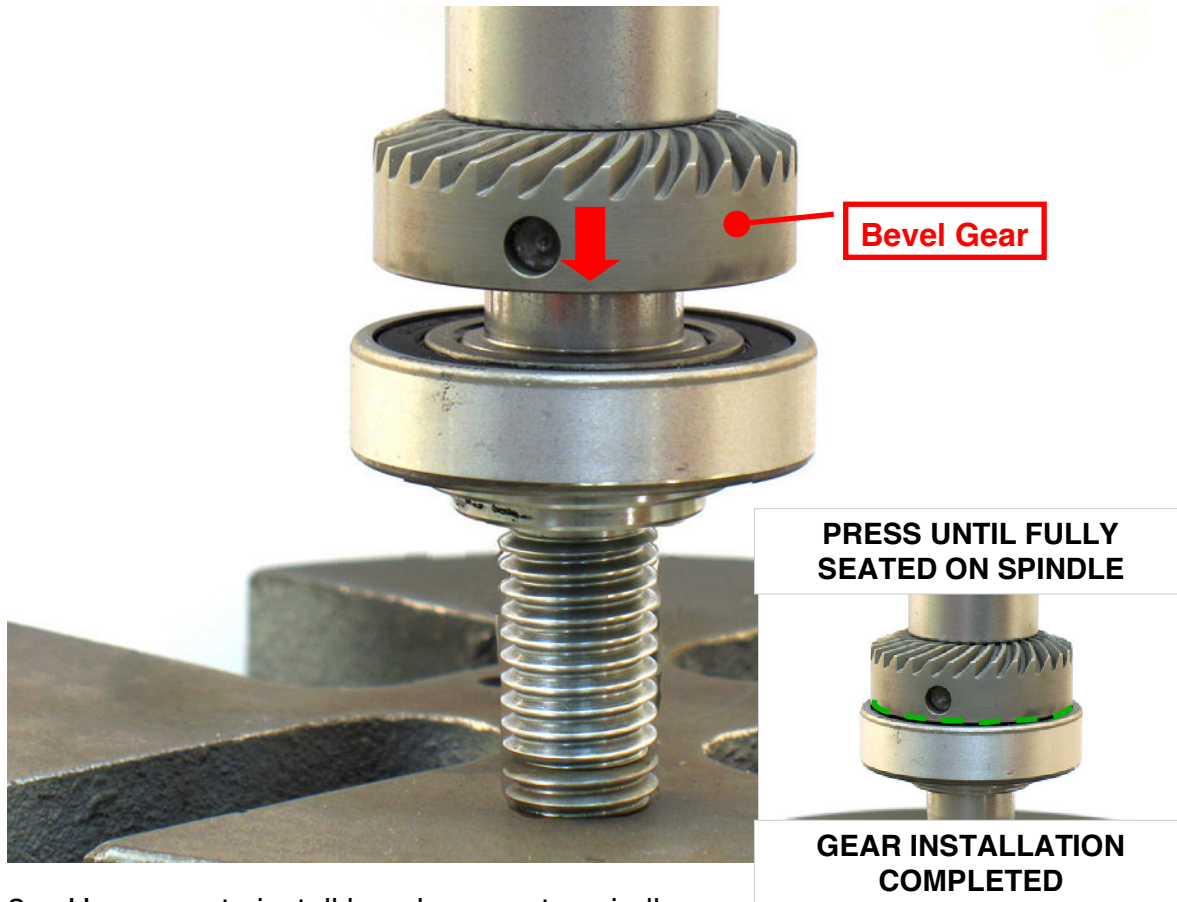

2. Use press to install bevel gear onto spindle.
 - Press until fully seated on spindle.

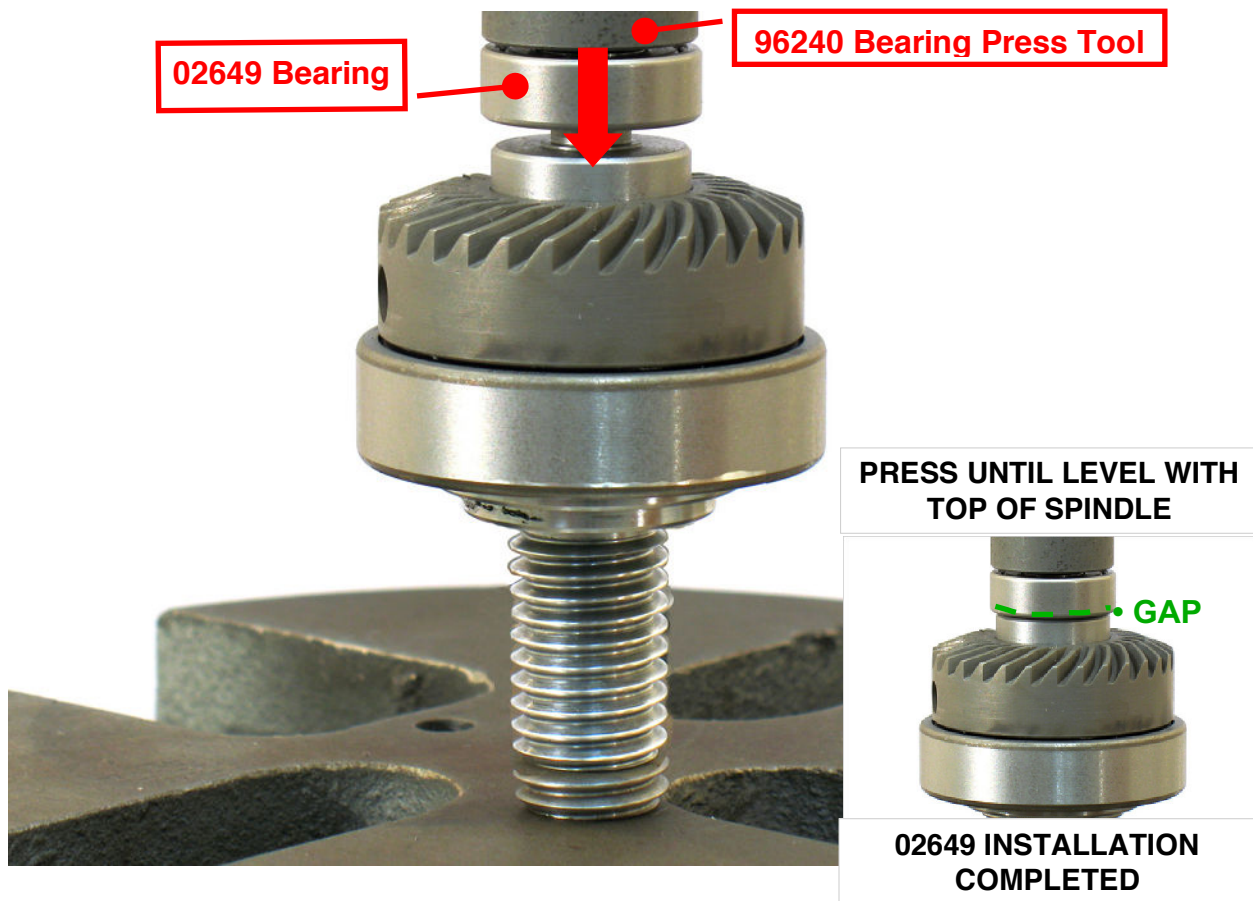

3. Use press and **96240** Bearing Press Tool to install **02649** Bearing onto spindle.
 - Press until bearing is level with top of spindle.



4. Fasten housing in vise (bronze or aluminum jaws). Install spindle assembly in housing.

- By hand, push down on spindle assembly and rotate spindle back and forth to check the amount of free movement (“backlash”) between the bevel and pinion gear teeth. Ideally, there should be minimal free movement between the teeth.
- Use an adjustable pin spanner (Ø 4mm pins) to fasten **54952** Lock Ring. Check 360° rotation of the spindle assembly. The correct fit should have minimal “backlash” without any restricted movement between the gears.
- When gear fit is too tight, add shim(s) to adjust and set the correct “backlash”.
- Notice: Once gears are adjusted correctly. Loosen **54952** Lock Ring and remove spindle assembly from housing.



5. Install **97995** Wave Disc.

**96747
GEAR GREASE
(14 grams)**

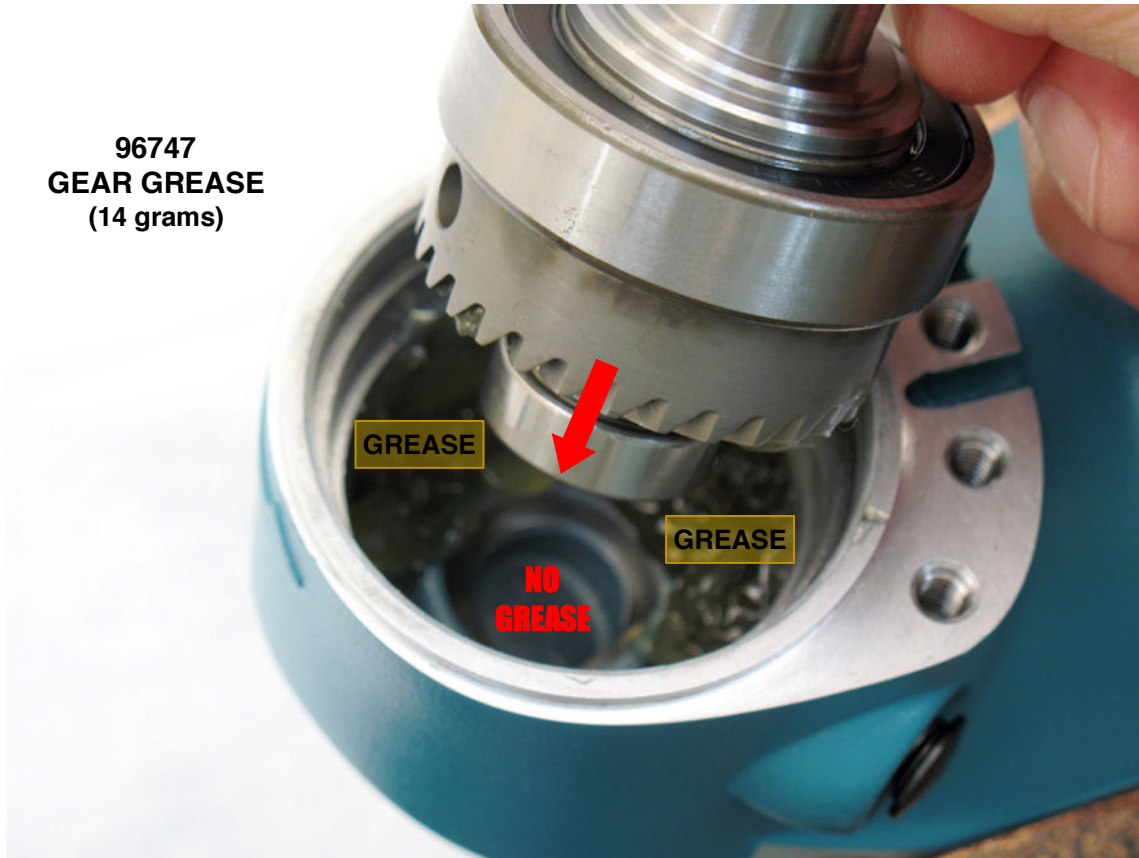

6. Apply 14 grams of **96747** Grease to housing cavities and pinion gear.
 - **Notice:** *Do not apply grease in “top spindle bearing pocket”*. Assembly will be difficult!
 - Install shims and spindle assembly.

Torque to 23 N•m/~200 lbs. in.

Loctite #567



7. Apply a small amount of Loctite #567 to threads of **54952** Lock Ring.
 - Use adjustable pin spanner (Ø 4mm pins) to install lock ring.
 - Torque to 23 N•m/~200 lbs. in.

Right angle gear assembly completed.

Final Assembly:

Lubrication:

- **Motor:** Dynabrade recommends 1 drop of oil per minute for every 20 SCFM. Example: Specification states 115 SCFM, set lubricator for ~6 drops/per minute.
- **Gears:** Replace grease at 1000 hours of use or when tool is rebuilt. Apply 14 grams of **96747** Grease according to instructions.

Operation:

- Refer to tool manual and follow directions for checking RPM before installing any accessories.
- Install guard and back-up flange. Use appropriate wrenches when installing accessories and outer flange.

Torque screws to: 9 N·m/~80 lbs. in.



8. Important: Use all five 96274 Screws to fasten guard (7" or 9") securely.
- Torque screws to: 9 N·m/~80 lbs. in.